

Nanjing Yowon Product Catalogue

Contents

- Company Profile 1-2
- Factory views 3-4
- Food trailer cases 5-6
- YF1 & YF2 model7-8
- YC1 & YC2 model 9-10
- YS model11-12
- YA model13-14
- Common used layout 15-18
- Customization process 19-20
- Configuration options21-22
- Gas operated equipment 23-28
- Electric cooking equipment ... 29-36
- Refrigerated equipment 37-40



Nanjing Yowon Machinery Technology Co., Ltd

南京言文机械科技有限公司

Web/网址: www.yowontech.com

Tel/ 电话: 008617356331846

Email/ 邮箱: yowonsales@foxmail.com

Address: No. 118 Zhongxin Rd, Qixia district, Nanjing city, China

地址: 南京市栖霞区中心路118号



Company Profile

Area covered **8000m²**

Incumbents **60+**



Nanjing Yowon Machinery company is a manufacturer of food trailer in China, we have been working on food service equipment since 2015.

The main products are including small fiberglass food trailer, classic square food trailer, stainless steel stream line food trailer, camping trailer, and food service equipment such as bakery equipment, refrigerated display case, ice cream machine, and lots of cooking equipment.

Our company is located in Nanjing city, Jiangsu Province, China. But we have factories in Shanghai, Nantong city, and Xuancheng city. The products from our company have been sold to many countries all over the world, we have CE, ISO, COC, and VIN for our products.

Welcome to visit our company if you are interested in working with us.

Yowon factory views



● Yowon food trailer factory
Located in Nantong
2 buildings covered +8000m²



● 2 fiberglass trailer (YF) production lines
Capacity: 80+ units each month



● 2 Airstream trailer (YA) production lines
Capacity: 30+ units each month



● factory gate



● raining test



● Loading area



● Display ground



● gas cylinder tanks



● water sinks



● fiberglass wall



● Outdoor storage ground



Food trailer cases

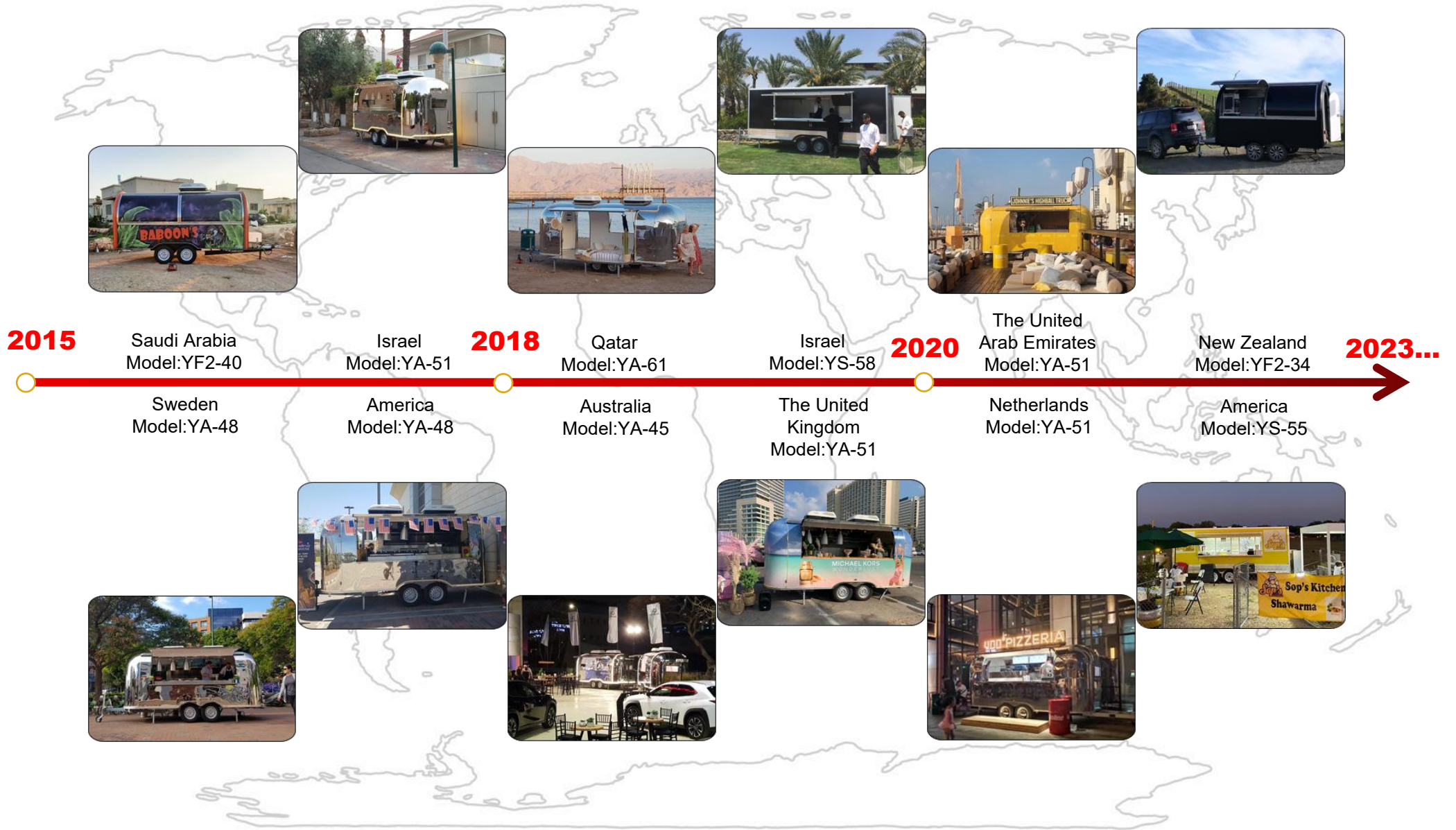

PS. YF1 model wide 165cm, YF2 model wide 200cm



Painted fiberglass food trailer

1. The shell of is model is made of fiberglass and color coated steel sheets, the frame and chassis is full welded galvanized steel tubes.
2. We can customize the color, white color for free, other colors need to pay. Painting cost \$300 for trailer body length not over 3m, \$450 for 3~5m length.
3. The trailer length can be customized, the width and height can't be.
4. This model do not have insulation inside the wall, extra cotton insulation need to pay.
5. We use different kinds of tires according to the trailer weight, we have 165/70 R13 79T, 185/60 R14 82H, 185R14C 102/100Q for this model .
6. The standard appliances for this trailer are tow bar, taillight system, electric system, lights inside, sockets, 2 layers sus201 working bench, back wall rack, service window, hang up shelf for service window, etc.
7. We need to confirm the required customization first before we give a quote, such as the food trailer length, color, equipment inside including the range hood, fridge, freezer, water sinks, fryer, griddle, stove, air conditioner, drawers, garbage bins, LED signboard on roof,etc.
8. Please contact our sales for more informations



YF1-23/28



YF1-34/40



YF2-23/28



YF2-34/40/45

Model	Over all size	Body size	Interior size	Weight	Payload	Axle	Brake	Tires	Workers	EXW price
YF1-23	350*165*230cm	230*165*230cm	210*148*200cm	370kg	580kg	1	no (optional)	165/70 R13 79T	1-2	\$2590
YF1-28	400*165*230cm	280*165*230cm	260*148*200cm	430kg	520kg	1	no (optional)	165/70 R13 79T	1-2	\$2920
YF1-34	460*165*230cm	340*165*230cm	320*148*200cm	580kg	470kg	1	no (optional)	185/60 R14 82H	2-4	\$3540
YF2-23	350*200*240cm	230*200*240cm	210*187*200cm	430kg	520kg	1	no (optional)	165/70 R13 79T	1-2	\$3140
YF2-28	400*200*240cm	280*200*240cm	260*187*200cm	520kg	430kg	1	no (optional)	165/70 R13 79T	2-3	\$3910
YF2-34	460*200*240cm	340*200*240cm	320*187*200cm	820kg	980kg	1	yes	185 R14C 102/100Q	2-4	\$5490
YF2-34	460*200*240cm	340*200*240cm	320*187*200cm	880kg	2620kg	2	yes	185 R14C 102/100Q	2-4	\$6090
YF2-40	520*200*240cm	400*200*240cm	380*187*200cm	950kg	2550kg	2	yes	185 R14C 102/100Q	2-5	\$7290

Adapted confugration :



coupling



jack wheel



stabilizer legs



axle no brake



axle with disc brake



alko torsion axle



coupling comes with brake



new stabilizer legs

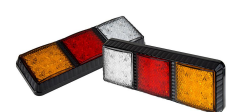

tail light system

PS. YC1 model wide 165cm, YC2 model wide 200cm

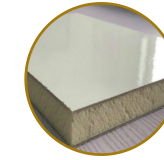

Materiel: 50mm thickness Polyurethane plate

Luxury curved shape galvanized steel food trailer

1. The shell of is model is made of solid Polyurethane plate and galvanized steel sheets, the interior wall is covered with stainless steelsheets. the frame and chassis is made of galvanized steel tubes.

2. We can customize the color, white color for free, other colors need to pay. Painting cost \$300 for trailer body length not over 3m, \$450 for 3~5m length.

3. The trailer length can be customized, the width and height can't be.

4. This model have Polyurethane and cotton as insulation inside the wall.

5. We use different kinds of tires according to the trailer weight, we have 165/70 R13 79T, 185/60 R14 82H, 185R14C 102/100Q for this model .

6. The standard appliances for this trailer are towbar, taillight system, electric system, lights inside, sockets, 2 layers sus201 working bench, back wall rack, service window, hang up shelf for service window, etc.

7. We need to confirm the required customization first before we give a quote, such as the food trailer length, color, equipment inside including the range hood, fridge, freezer, water sinks, fryer, griddle, stove, air conditioner, drawers, garbage bins, LED signboard on roof,etc.

8. Please contact our sales for more informations.



YC1-23/28/34



YC2-23/28/34/40

Model	Over all size	Body size	Interior size	Weight	Payload	Axle	Brake	Tires	Workers	EXW price
YC1-23	350*165*230cm	230*165*230cm	210*148*200cm	510kg	440kg	1	no (optional)	165/70 R13 79T	1-2	\$3470
YC1-28	400*165*230cm	280*165*230cm	260*148*200cm	600kg	450kg	1	no (optional)	185/60 R14 82H	1-2	\$4160
YC1-34	460*165*230cm	340*165*230cm	320*148*200cm	750kg	1050kg	1	yes	185 R14C 102/100Q	2-4	\$5080
YC2-23	350*200*240cm	230*200*240cm	210*187*200cm	590kg	460kg	1	no (optional)	185/60 R14 82H	1-2	\$4270
YC2-28	400*200*240cm	280*200*240cm	260*187*200cm	710kg	1090kg	1	yes	185 R14C 102/100Q	2-3	\$5140
YC2-34	460*200*240cm	340*200*240cm	320*187*200cm	1050kg	750kg	1	yes	185 R14C 102/100Q	2-4	\$6090
YC2-34	460*200*240cm	340*200*240cm	320*187*200cm	1100kg	2400kg	2	yes	185 R14C 102/100Q	2-4	\$6690
YC2-40	520*200*240cm	400*200*240cm	380*187*200cm	1200kg	2300kg	2	yes	185 R14C 102/100Q	2-5	\$7770

Adapted confugration :



coupling



jack wheel



stabilizer legs



axle no brake



axle with dsic brake



alko tursion axle



coupling comes with brake



new stabilizer legs



tail light system

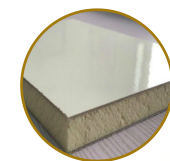

Materiel: 50mm thickness Polyurethane plate

Square shape polyurethane foamed sandwich board food trailer

1. The shell of is kind of food trailer is made of 50mm solid Polyurethane foamed sandwich board, the chassis is made of galvanized steel tubes.
2. We can customize the color, white and black color for free, other colors need to pay. Painting cost \$500 for 5m trailer and less, \$800 for 8m trailer and less.
3. The trailer length can be customized, the width and height can't be.
4. This model have Polyurethane as insulation inside the wall.
5. We use different kinds of tires for our food trailers, we use 175R14LT 99/97R, 185R14C 102/100Q for this model according to the trailer weight.
6. The standard appliances for this trailer are towbar, taillight system, electric system, lights inside, sockets, service window, foldable rack under service window etc.
7. Customizations for this kind of food trailer are including working bench,extra windows, range hood, fridge, freezer, water sinks, cooking equipment, air conditioner, drawers, draw-out garbage bins, LED signboard on roof, etc.
8. Please contact our sales for more informations.



Model	Over all size	Body size	Interior size	Weight	Payload	Axle	Brake	Tires	Workers	EXW price
YS-28	400*210*260cm	280*210*260cm	270*200*200cm	790kg	1010kg	1	yes	185 R14C 102/100Q	1-3	\$5900
YS-38	500*210*260cm	380*210*260cm	370*200*200cm	1050kg	750kg	1	yes	185 R14C 102/100Q	2-4	\$6800
YS-48	600*210*260cm	480*210*260cm	470*200*200cm	1360kg	2140kg	2	yes	185 R14C 102/100Q	2-5	\$8500
YS-58	700*210*260cm	580*210*260cm	570*200*200cm	1600kg	1900kg	2	yes	185 R14C 102/100Q	2-5	\$9700
YS-68	800*210*260cm	680*210*260cm	670*200*200cm	1850kg	1650kg	2	yes	185 R14C 102/100Q	3-5	\$11300
YS-68	800*200*240cm	680*210*260cm	670*200*200cm	1910kg	3190kg	3	yes	185 R14C 102/100Q	3-5	\$12100
YS-78	900*200*240cm	780*210*260cm	770*200*200cm	2160kg	2940kg	3	yes	185 R14C 102/100Q	3-6	\$13900
YS-88	1000*200*240cm	880*210*260cm	870*200*200cm	2400kg	2700kg	3	yes	185 R14C 102/100Q	4-8	\$16100

Adapted confugration :



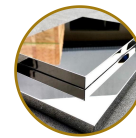

shiny stainless steel

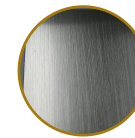

matte stainless steel



Glass wool insulation

Airstream model stainless steel food trailer

1. The wall of this model is 50mm thickness, the outside surface is covered with 1.2mm stainless steel sheets, the interior surface is covered with fiberglass sheets, we can also customize the inside wall surface to be stainless steel. The chassis is fully welded by galvanized steel tubes.

2. The shiny stainless steel and matt stainless steel are optional, please tell our sales which kind of stainless steel shell you want. We can also paint this model, Painting cost \$500 for trailer length not over 5m, \$800 for 5~8m length.

3. The trailer length can be customized, the width and height can't be.

4. This model have Glass wool as insulation inside the wall.

5. We use different kinds of tires according to food trailers weight, we use 185R14C 102/100Q for this model.

6. The standard appliances for this trailer are tow bar, taillight system, electric system, lights inside, sockets, service window, foldable step under the door, etc.

7. Customizations for this kind of food trailer are including working bench, extra windows, range hood, fridge, freezer, water sinks, cooking equipment, air conditioner, drawers, draw-out garbage bins, LED signboard on roof, etc.

8. Please contact our sales for more informations..

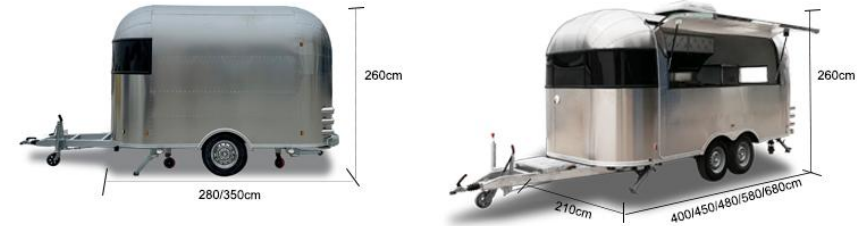

YA-28/35

YA-40/45/48/58/68



YA-68/78/88

Model	Over all size	Body size	Interior size	Weight	Payload	Axle	Brake	Tires	Workers	EXW price
YA-28	400*210*260cm	280*210*260cm	260*200*200cm	840kg	960kg	1	yes	185 R14C 102/100Q	1-3	\$10800
YA-35	470*210*260cm	350*210*260cm	330*200*200cm	1050kg	750kg	1	yes	185 R14C 102/100Q	2-4	\$11500
YA-40	520*210*260cm	400*210*260cm	380*200*200cm	1200kg	2300kg	2	yes	185 R14C 102/100Q	2-4	\$12700
YA-45	570*210*260cm	450*210*260cm	430*200*200cm	1410kg	2090kg	2	yes	185 R14C 102/100Q	2-5	\$13300
YA-48	600*210*260cm	480*210*260cm	460*200*200cm	1500kg	2000kg	2	yes	185 R14C 102/100Q	2-5	\$13660
YA-58	700*200*240cm	580*210*260cm	560*200*200cm	1800kg	1700kg	2	yes	185 R14C 102/100Q	3-5	\$15160
YA-68	800*200*240cm	680*210*260cm	660*200*200cm	2100kg	1400kg	2	yes	185 R14C 102/100Q	3-6	\$16960
YA-68	800*200*240cm	680*210*260cm	660*200*200cm	2160kg	2940kg	3	yes	185 R14C 102/100Q	3-6	\$17760
YA-78	900*200*240cm	780*210*260cm	760*200*200cm	2340kg	2760kg	3	yes	185 R14C 102/100Q	4-8	\$19760

Adapted configuration :



coupling comes with brake



jack wheel



stabilizer legs



axle with disc brake



alko coupling comes with brake



alko jack wheel



alko axle with brake



new stabilizer leg



tail light system

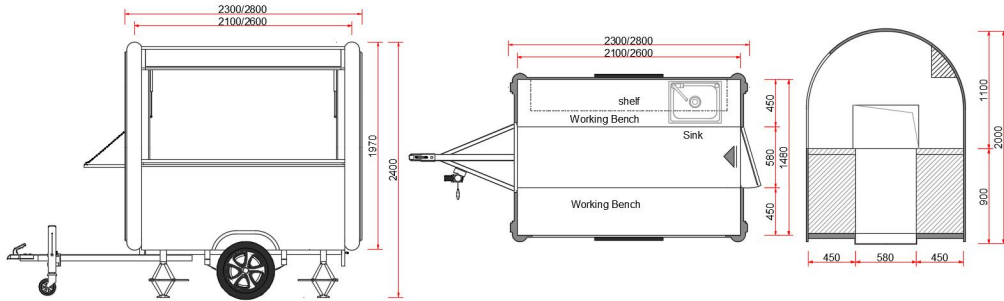

Plan 1 model : YF1-23/28 (It can be adapted to model FC1-23/28.)

Standard configuration

- white baking paint
- single axle no brake
- tow bar with jack wheel and safty chain
- service window with suspended shelf
- stainless steel working bench
- back wall stainless steel shelf
- tail light system and connector
- electric wires, sockets, lights...

Customized equipment

- single sink

Optional equipment

- air conditioner
- range hood
- fridge/ freezer
- fryer,griddle, stove ...

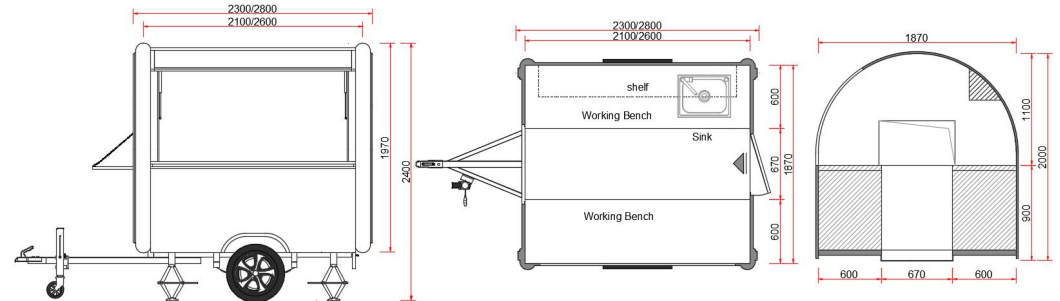

Plan 2 model : YF2-23/28 (It can be adapted to model FC2-23/28.)

Standard configuration

- white baking paint
- single axle no brake
- tow bar with jack wheel and safty chain
- service window with suspended shelf
- stainless steel working bench
- back wall stainless steel shelf
- tail light system and connector
- electric wires, sockets, lights...

Customized equipment

- single sink

Optional equipment

- air conditioner
- range hood
- fridge/ freezer
- fryer,griddle, stove ...

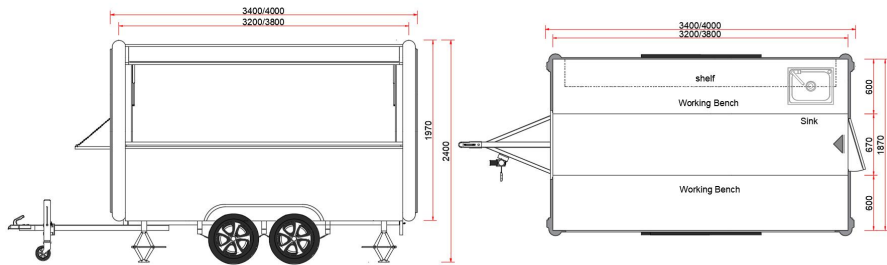

Plan 3 model : YF2-34/40 (It can be adapted to model FC2-34/40.)

Standard configuration

- white baking paint
- single axle with disc brake
- tow bar with jack wheel and safty chain
- service window with suspended shelf
- stainless steel working bench
- back wall stainless steel shelf
- tail light system and connector
- electric wires, sockets, lights...

Customized equipment

- single sink

Optional equipment

- air conditioner
- range hood
- fridge/ freezer
- fryer,griddle, stove ...

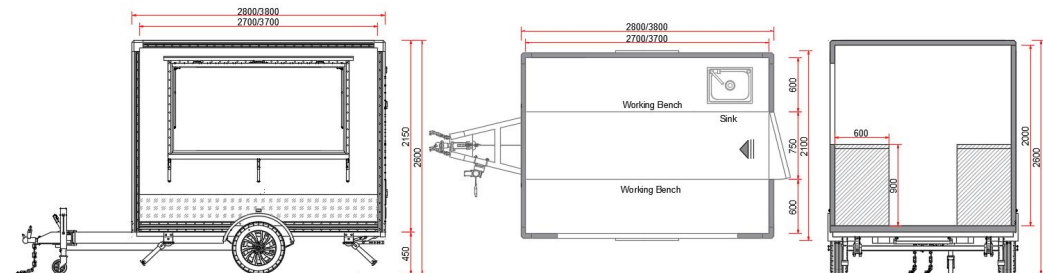

Plan 4 model : YS-28/38

Standard configuration

- white and black baking paint
- single axle with disc brake
- tow bar with jack wheel and safty chain
- service window with foldable shelf
- tail light system and connector
- foldable footstep under the door
- electric wires, sockets, lights...

Customized equipment

- single sink
- stainless steel working bench

Optional equipment

- air conditioner
- range hood
- fridge/ freezer
- fryer,griddle, stove ...

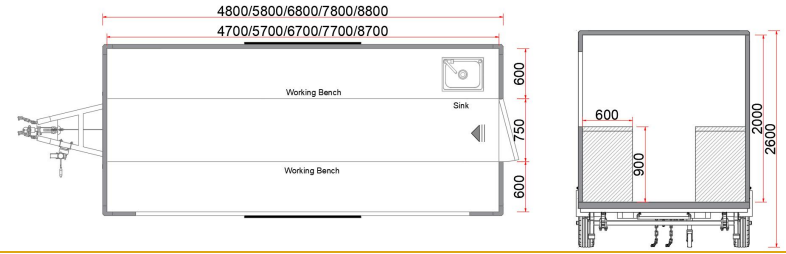
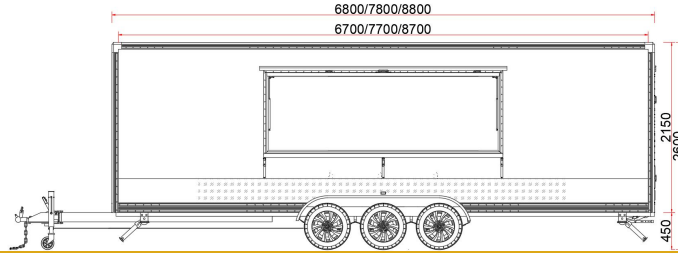
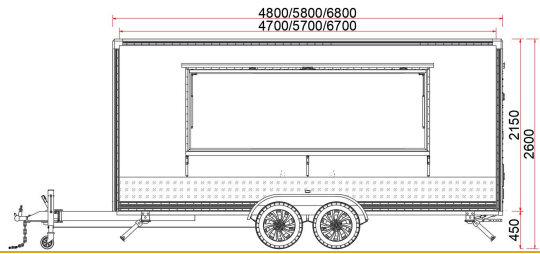

Plan 5 model : YS-48/58/68 (2 axles)

Standard configuration

- white and black baking paint
- double axles with disc brake
- tow bar with jack wheel and safty chain
- service window with foldable shelf
- tail light system and connector
- foldable footstep under the door
- electric wires, sockets, lights...

Customized equipment

- single sink
- stainless steel working bench

Optional equipment

- air conditioner
- range hood
- fridge/ freezer
- fryer,griddle, stove ...

Plan 6 model : YS68/78/88 (3 axles)

Standard configuration

- white and black baking paint
- triple axles with disc brake
- tow bar with jack wheel and safty chain
- service window with foldable shelf
- tail light system and connector
- foldable footstep under the door
- electric wires, sockets, lights...

Customized equipment

- single sink
- stainless steel working bench

Optional equipment

- air conditioner
- range hood
- fridge/ freezer
- fryer,griddle, stove ...

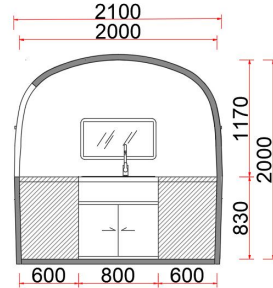
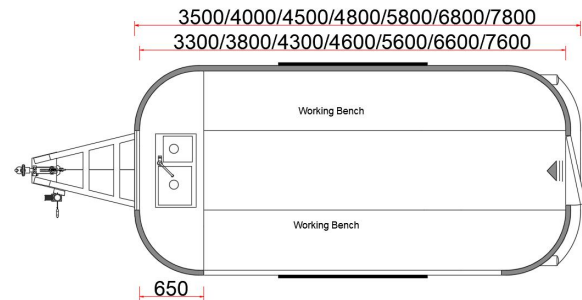
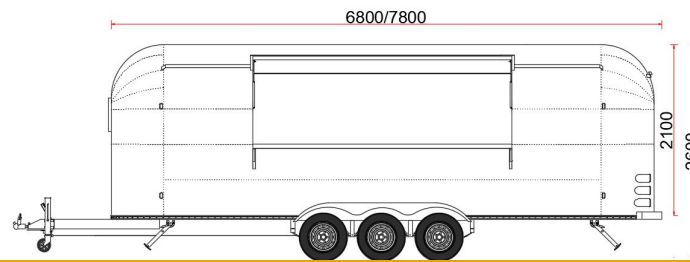
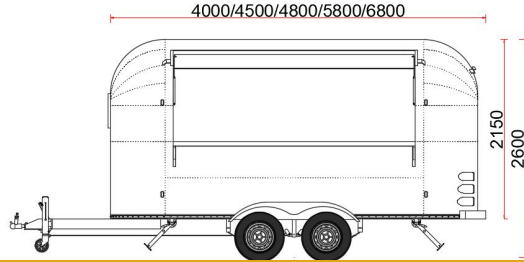

Plan 7 model : YA-28/35

- single axle with disc brake

Standard configuration

- shiny or matte stainless steel shell
- tow bar with jack wheel and safty chain
- service window with foldable shelf
- tail light system and connector
- foldable footstep under the door
- electric wires, sockets, lights...

Plan 8 model : YA-40/45/48/58/68

- double axles with disc brake

Customized equipment

- double sink
- stainless steel working bench

Optional equipment

- air conditioner
- range hood
- fridge/ freezer
- fryer,griddle, stove ...

Plan 9 model : YA-68/78

- triple axles with disc brake

Customization process

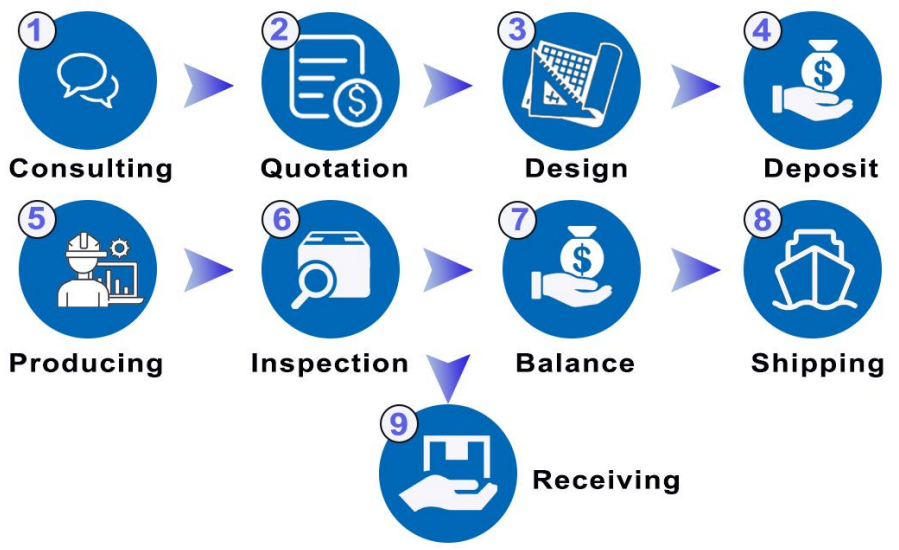

Production 20-30days + shipping 20-30days

INCOTERMS	SELLER	FIRST CARRIER	ALONGSIDE SHIP	ON BOARD	ARRIVAL	ALONGSIDE SHIP	DESTINATION PLACE	BUYER WAREHOUSE
EXW	EX WORKS	!						
FCA	FREE CARRIER	!						
FAS	FREE ALONGSIDE SHIP		!					
FOB	FREE ON BOARD			!				
CFR	COST AND FREIGHT			!				
CIF	COST, INSURANCE AND FREIGHT			!				
CPT	COST PAID TO...	!						
CIP	CARRIER AND INSURANCE PAID TO...						!	
DAT	DELIVERY AT TERMINAL						!	
DAP	DELIVERY AT PLACE						!	
DDP	DELIVERY DUTY PLACE							!

LEGEND: ■ SELLER'S OBLIGATION ■ BUYER'S OBLIGATION ! RISK TRANSFER POINTS

- 1. Consulting:** We need to confirm the food trailer length and equipment/ function that you want, and also which seaport we ship to. If you are not sure about the length, please tell us how many workers inside, then we will give you a suitable length.
- 2. Quotation:** Once our sales have confirmed with your about all requirements, you will receive a detailed quotation very soon.
- 3. Design:** You will receive the design from our sales if the quotation is confirmed. So you can see how is your food trailer looks like.
- 4. Deposit:** We do 50% deposit, you can pay through Alibaba online trade assurance order.
- 5. Producing:** The production time is about 20-30days for one unit, we will send you photos or videos to show you the process.
- 6. Inspection:** Your food trailer will be tested before shipping. Including raning test, driving test, electricity test, water system test.
- 7. Balance:** When you are satisfied with your completed food trailer, then please pay the balance and prepare to receive it.
- 8. Shipping:** Our sales will contact the shipping company to book a ship after you pay the balance. The shipping time is about 20-30days according to the destination .

Payment method

Offline order	Online order
T/T WESTERN UNION WU	VISA, mastercard, T/T, PayPal Apple Pay, Google Pay, Online Transfer

How many trailers can be loaded in a container?

units	YF1-23	YF2-23	YF2-28	YA-40	YA-48	YA-68
20GP	3	2	2	1	1	0
40HQ	7	5	4	3	2	1

simple SUS bench (YA,YS) \$100/meter	SUS working bench (YA,YS) \$120/meter	SUS sliding door for bench \$60/meter	SUS sliding door for shelf \$50/meter	wall cabinet (YA,YS) \$120/meter	4 drawers under bench \$400	cash drawer \$50	drawer garbage bins \$120 (45cm bench) \$200 (60cm bench)
Aluminium gas cylinder tank \$230	Stainless steel generator box \$250	Stainless steel gas cylinder box \$180	range hood turbulence exhaust fan \$400/ meter	range hood upblast exhaust fan \$900/meter	one more service window (YF,YC) \$300	one more service window (YA,YS) \$500	service window sliding glass \$500
stainless steel interior wall \$30/m ²	220V Air conditioner 9000BUT \$600 12000BUT \$800	110V Air conditioner 9000BTU \$800 12000BTU \$1000	220V roof mounted A/C 11000BUT \$1450	110V roof mounted A/C 11000BUT \$1650	silent diesel generator 5kw \$1100 8kw \$1300 10kw \$1500	alko torsion axle no brake with tires \$400 (750kg) \$600 (1200kg)	alko torsion axle with brake with tires \$700 (750kg) \$1100 (1200kg) \$1400 (1800kg)
single square sink 50*40cm, with pump \$140	double square sink 82*50cm, with pump \$240	3 compartment sinks 100*42cm, with pump \$520	hand washing sink with pump \$120	automatic water pump pressure sensor \$100	hot water heater 10L, 220V, 2kw \$220	hot water heater 10L,110V, 2kw \$250	food grade water sink 40L, 70L, 90L free for sink
extra socket \$20	service window drop lights 3 units \$200	tracking lights 1meter 4 lights \$150	roof LED light box 100*50cm \$400 200*50cm \$600	roof sign board \$800	LED strip light \$15/meter	amplifier and two speakers \$220	





counter top gas fryer

model: GF-71
size: 29*52*46cm
BTU: 16000
weight: 9.5kg
capacity: 6L
price: **\$100**



counter top gas fryer

model: GF-72
size: 58*52*46cm
BTU: 32000
weight: 20kg
capacity: 2x6L
price: **\$200**



counter top gas fryer

model: GF-535
size: 40*65*48cm
BTU: 19000
weight: 20kg
capacity: 14L
price: **\$420**



counter top gas fryer

model: GF-585
size: 60*65*48cm
BTU: 38000
weight: 25kg
capacity: 2x14L
price: **\$520**



counter top gas griddle

model: GH-720
size: 73*55*40cm
BTU: 32000
weight: 31kg
griddle: 727*700*8mm
price: **\$180**



counter top gas griddle

model: GH-412
size: 120*61*40cm
BTU: 61000
weight: 72kg
griddle: 1198*465*12mm
price: **\$550**



counter top gas griddle

model: GH-536
size: 40*65*48cm
BTU: 19000
weight: 30kg
griddle: 400*500*16mm
price: **\$470**



counter top gas griddle

model: GH-586
size: 60*65*48cm
BTU: 28000
weight: 43kg
griddle: 600*500*16mm
price: **\$520**



counter top gas stove

model: GH-537
size: 40*65*48cm
BTU: 27200
weight: 31.5kg
price: **\$470**



counter top gas stove

model: GH-587
size: 60*65*48cm
BTU: 55000
weight: 45kg
price: **\$520**



counter top gas pasta cooker

model: GH-538
size: 40*65*48cm
BTU: 19000
weight: 17.5kg
price: **\$470**



counter top gas pasta cooker

model: GH-588
size: 60*65*48cm
BTU: 34000
weight: 25kg
price: **\$500**



counter top gas bain marie

model: GH-534
size: 40*65*48cm
BTU: 13600
weight: 20kg
price: **\$400**



counter top gas bain marie

model: GH-584
size: 60*65*48cm
BTU: 14000
weight: 29kg
price: **\$470**



counter top gas lava rock grill

model: GB-539
size: 40*65*48cm
BTU: 17000
weight: 35kg
price: **\$420**



counter top gas lava rock grill

model: GB-589
size: 60*65*48cm
BTU: 34000
weight: 50kg
price: **\$500**



gas fryer with cabinet

model: GF-775(700)
size: 40*73*94cm
BTU: 68000
weight: 48kg
capacity: 28L
price: **\$820**



gas griddle with cabinet

model: GF-776Z(700)
size: 40*73*94cm
BTU: 17000
weight: 58kg
griddle: 580*341*16mm
price: **\$780**



gas lava rock grill with cabinet

model: GB-779(700)
size: 40*73*94cm
BTU: 28000
weight: 94kg
price: **\$770**



gas stove with cabinet

model: GH-777(700)
size: 40*73*94cm
BTU: 27000
weight: 42kg
price: **\$730**



gas bain marie with cabinet

model: GH-774Z(700)
size: 40*73*94cm
BTU: 17000
weight: 42kg
price: **\$670**



gas pasta cooker with cabinet

model: GH-778(700)
size: 40*73*94cm
BTU: 24000
weight: 42kg
price: **\$740**



gas griddle with cabinet (1/3 grooved)

model: GH-786(700)
size: 80*73*94cm
BTU: 41000
weight: 81kg
price: **\$1270**



gas griddle with cabinet (1/3 grooved)

model: GH-786(700)
size: 80*73*94cm
BTU: 41000
weight: 81kg
price: **\$1270**



4 burners gas stove with cabinet

model: GH-787(700)
size: 80*73*94cm
BTU: 55000
weight: 91kg
price: **\$1030**



western gas wok with cabinet

model: GH-782
size: 80*73*94cm
BTU: 41000
weight: 138kg
price: **\$1350**



gas bain marie with cabinet

model: GH-784(700)
size: 80*73*94cm
BTU: 17000
weight: 53kg
price: **\$1090**



gas lava rock grill with cabinet

model: GB-789(700)
size: 80*73*94cm
BTU: 48000
weight: 94kg
price: **\$1270**



gas pasta cooker with cabinet

model: GH-788(700)
size: 80*73*94cm
BTU: 24000
weight: 63kg
price: **\$1200**



gas griddle with oven (1/3 grooved)

model: GH-786A
size: 80*73*94cm
BTU: 41000+20000
griddle: 625*500*16mm
oven: 575*650*300mm
weight: 128kg
price: **\$1470**



4 burners gas stove with oven

model: GH-787A(700)
size: 80*73*94cm
BTU: 55000+20000
oven: 575*650*300mm
weight: 91kg
price: **\$1280**



4 burners gas stove & griddle & oven

model: GH-796A(700)
size: 120*73*94cm
BTU: 55000+20000+17000
griddle: 352*433*16mm
oven: 575*650*300mm
weight: 170kg
price: **\$1680**



gas kebab/shawama machine

model: GB-800
size: 54*63*80cm
BTU: 39000
weight: 23kg
price: **\$390**



gas kebab/shawama machine

model: GB-950
size: 54*63*95cm
BTU: 53000
weight: 27kg
price: **\$460**



gas smokless barbecue grill

model: GB-580
size: 58*42*23cm
BTU: 12000
roast area: 40*18cm
weight: 7kg
price: **\$100**



gas smokless barbecue grill

model: GB-220
size: 110*48*23.5cm
BTU: 25000
roast area: 78*26cm
weight: 12.7kg
price: **\$160**



gas infrared salamander

model: GT-14
size: 69*49*61cm
BTU: 28000
weight: 33kg
price: **\$340**



gas infrared salamander

model: GT-16
size: 88*44*61cm
BTU: 36000
weight: 42kg
price: **\$390**



gas crepe maker

model: GC-1
size: 45*58*21cm
BTU: 12000
weight: 17kg
price: **\$130**



gas crepe maker

model: GC-2
size: 90*58*21cm
BTU: 24000
weight: 32kg
price: **\$260**



gas chicken rotisseries
 model: GB-366
 size: 81*63*61cm
 voltage: 220V
 BTU: 28000
 weight: 63kg
 price: **\$420**



10L chorris machine
 model: NP-291
 size: 68*44*34cm
 voltage: -
 capacity: 10L
 weight: 22kg
 price: **\$420**



build-in gas stove with timing function
 model: YGS-1
 size: 33*43*19.5cm
 power: 5.2kw
 weight: 5.5kg
 price: **\$80**



build-in gas stove with timing function
 model: YGS-2
 size: 75*43*18cm
 power: 5.2+5.2kw
 weight: 11kg
 price: **\$160**



wood fire pizza oven
 model: YWP-1
 size: 104*88*110cm
 voltage: -
 capacity: 3x12 inches
 weight: 95kg
 price: **\$1750**



wood fire pizza oven
 model: YWP-2
 size: 104*88*110cm
 voltage: -
 capacity: 3x12 inches
 weight: 125kg
 price: **\$2100**



wood fire pizza oven
 model: YWP-3
 size: 78*67*200cm
 voltage: -
 capacity: 3x12 inches
 weight: 65kg
 price: **\$1850**



wood fire pizza oven
 model: YWP-4
 size: 84*90*206cm
 voltage: -
 capacity: 5x12 inches
 weight: 140kg
 price: **\$1950**



single gas wok
 model: YGW-1
 size: 88*80*80cm
 voltage: -
 weight: 40kg
 price: **\$290**



double gas wok
 model: YGW-2
 size: 150*80*80cm
 voltage: -
 weight: 60kg
 price: **\$380**



6 trays gas rice steamer
 model: ZG-HL-G6
 size: 70*68.5*104cm
 tray size: 60*40*4.5cm
 weight: 55kg
 price: **\$520**

OVERRUN DEVICES

AL-KO brake system

TECHNOLOGY

- 1 Pull bar (pushing force)
- 2 Reversal
- 3 Tensile force
- 4 Wheel brake

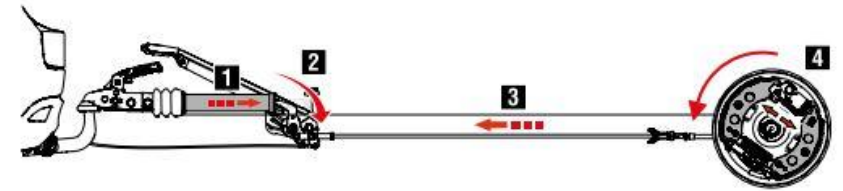

HOW TO READ YOUR TYRE SIZE

Tyre width (mm)	Height of the tyre sidewall as the % of the tyre width (=55%)	Rim diameter (inches)	Load index
235	55	R20	102T

Rotation Direction
Construction (R- radial)
Speed Index

counter top electric fryer



model: DF-8L
size: 26.5*42.5*33cm
voltage: 220V
power: 2.8kw
capacity: 8L
weight: 4kg
price: **\$100**

counter top electric fryer
2 tanks



model: DF-8L-2
size: 26.5*42.5*33cm
voltage: 220V
power: 2x2.8kw
capacity: 2x8L
weight: 8kg
price: **\$200**

counter top electric fryer



model: DF-635
size: 40*65*48cm
voltage: 220V
power: 3.8kw
capacity: 14L
weight: 12.6kg
price: **\$400**

counter top electric fryer
2 tanks



model: DF-685
size: 60*65*48cm
voltage: 220V
power: 2x3.8kw
capacity: 2x14L
weight: 18kg
price: **\$450**

counter top electric griddle



model: EG-820
size: 73*45*24cm
voltage: 220V
power: 4.4kw
griddle: 727*400*8mm
weight: 24kg
price: **\$120**

counter top electric griddle



model: EG-412
size: 120*56*33cm
voltage: 3N-380V
power: 16kw
griddle: 1198*465*12mm
weight: 72kg
price: **\$550**

counter top electric griddle



model: EG-636
size: 40*65*48cm
voltage: 220V
power: 4.05kw
griddle: 400*500*16mm
weight: 36kg
price: **\$420**

counter top electric griddle



model: EG-686
size: 60*65*48cm
voltage: 220V
power: 5.4kw
griddle: 600*500*16mm
weight: 51kg
price: **\$490**

electric pasta cooker



model: EH-488
size: 43*60*34cm
voltage: 220V
power: 4kw
weight: 14kg
price: **\$210**

electric pasta cooker



model: EH-688A
size: 60*60*34cm
voltage: 220V
power: 6kw
weight: 20kg
price: **\$330**

counter top electric
pasta cooker



model: EH-638
size: 40*65*48cm
voltage: 220V
power: 4.5kw
weight: 14kg
price: **\$420**

counter top electric
pasta cooker



model: EH-688
size: 60*65*48cm
voltage: 220V
power: 6kw
weight: 20kg
price: **\$450**

electric bain marie



model: EH-4
size: 69*58*26cm
voltage: 220V
power: 1.5kw
weight: 13kg
price: **\$160**

electric bain marie



model: EH-6
size: 69*58*26cm
voltage: 220V
power: 1.5kw
weight: 11kg
price: **\$200**

counter top electric bain
marie



model: EH-634
size: 40*65*48cm
voltage: 220V
power: 1.5kw
weight: 13kg
price: **\$360**

counter top electric bain
marie



model: EH-684
size: 60*65*48cm
voltage: 220V
power: 1.5kw
weight: 18.5kg
price: **\$410**

counter top electric 2
plate cooker



model: EH-637
size: 40*65*48cm
voltage: 220V
power: 4.6kw
weight: 13kg
price: **\$410**

counter top electric 4
plate cooker



model: EH-687
size: 60*65*48cm
voltage: 220V
power: 8kw
weight: 18.5kg
price: **\$460**

counter top electric lava
rock grill



model: EB-639
size: 40*65*48cm
voltage: 220V
power: 3.9kw
weight: 25kg
price: **\$430**

counter top electric lava
rock grill



model: EB-689
size: 60*65*48cm
voltage: 220V
power: 7.8kw
weight: 36kg
price: **\$480**



electric fryer with cabinet

model: DF-775
size: 40*73*94cm
voltage: 380V
power: 9kw
capacity: 28L
weight: 48kg
price: **\$820**



electric griddle with cabinet

model: EH-776Z
size: 40*73*94cm
voltage: 380V
power: 4.1kw
griddle: 341*535*16mm
weight: 58kg
price: **\$780**



electric 2 plate cooker with cabinet

model: EH-777B
size: 40*73*94cm
voltage: 380V
power: 5.2kw
weight: 58kg
price: **\$780**



electric pasta cooker with cabinet

model: EH-778
size: 40*73*94cm
voltage: 380V
power: 9kw
weight: 42kg
price: **\$740**



electric lava rock grill with cabinet

model: EB-779
size: 40*73*94cm
voltage: 380V
power: 5.4kw
weight: 68kg
price: **\$770**



electric bain marie with cabinet

model: EH-774Z
size: 40*73*94cm
voltage: 380V
power: 3kw
weight: 42kg
price: **\$670**



electric fryer with cabinet

model: DF-785
size: 80*73*94cm
voltage: 380V
power: 2x9kw
capacity: 2x28L
weight: 65kg
price: **\$1260**



electric griddle with cabinet (1/3 grooved)

model: EG-786
size: 80*73*94cm
voltage: 380V
power: 11kw
griddle: 735*535*16mm
weight: 82kg
price: **\$1240**



electric 4 plate cooker with cabinet

model: EH-787C
size: 80*73*94cm
voltage: 3N-380V
power: 10.4kw
griddle: 727*400*8mm
weight: 80kg
price: **\$1120**



electric pasta cooker with cabinet

model: EH-788
size: 80*73*94cm
voltage: 3N-380V
power: 2x9kw
weight: 63kg
price: **\$1050**



electric lava rock grill with cabinet

model: EB-789
size: 80*73*94cm
voltage: 380V
power: 8.1kw
weight: 95kg
price: **\$1250**



electric bain marie with cabinet

model: EH-784
size: 80*73*94cm
voltage: 380V
power: 6kw
weight: 60kg
price: **\$980**



electric griddle with oven (1/3 grooved)

model: EG-786A
size: 80*73*94cm
voltage: 380V
power: 11.6kw
griddle: 625*500*16mm
oven: 575*650*300mm
weight: 110kg
price: **\$1350**



electric 4 plate cooker with oven

model: EH-787B
size: 80*73*94cm
voltage: 380V
power: 13.9kw
oven: 575*650*300mm
weight: 95kg
price: **\$1200**



electric doner kebab machine

model: EB-808
size: 58*63*95cm
voltage: 220V
power: 8.1kw
weight: 25.7kg
price: **\$460**



electric hanging salamander

model: AT-936
size: 57*34*27cm
voltage: 220V
power: 2.3kw
weight: 9kg
price: **\$130**



electric lift salamander

model: EB-450
size: 45*45*47cm
voltage: 220V
power: 2.8kw
weight: 34kg
price: **\$400**



electric lift salamander

model: EB-600
size: 60*45*47cm
voltage: 220V
power: 6.8kw
weight: 49kg
price: **\$560**



electric crepe maker

model: DE-1
size: 45*48.5*24cm
voltage: 220V
power: 3kw
hot plate: Φ 395
weight: 19kg
price: **\$140**



electric crepe maker

model: DE-2
size: 86*48.5*24cm
voltage: 220V
power: 6kw
hot plate: Φ 395
weight: 36kg
price: **\$280**



electric panini grill (top grooved bottom flat)

model: EG-811C
size: 31*37*21cm
voltage: 220V
power: 1.8kw
weight: 12kg
price: **\$140**



electric panini grill (top grooved bottom flat)

model: EG-812E
size: 42.5*37*21cm
voltage: 220V
power: 2.2kw
weight: 15kg
price: **\$220**



electric panini grill

model: EG-811
size: 31*37*21cm
voltage: 220V
power: 1.8kw
weight: 12.3kg
price: **\$140**



electric double panini grill

model: EG-813
size: 57*37*21cm
voltage: 220V
power: 3.6kw
weight: 27kg
price: **\$270**



electric warming showcase

model: DH-2X2
size: 70*64*73cm
voltage: 220V
power: 0.8kw
weight: 27kg
price: **\$250**



electric warming showcase

model: DH-2X4
size: 120*64*73cm
voltage: 220V
power: 1kw
weight: 43kg
price: **\$360**



curved glass warming showcase

model: R60-2
size: 66*49*61.5cm
voltage: 220V
power: 1.2kw
weight: 36kg
price: **\$200**



curved glass warming showcase

model: R60-1
size: 90*49*61.5cm
voltage: 220V
power: 1.84kw
weight: 56kg
price: **\$250**



electric pizza warmer

model: DH-E1
size: 49.5*53*70cm
voltage: 220V
power: 1.2kw
weight: 15kg
price: **\$380**



electric 5 layers warmer

model: DH-E1X
size: 49.5*53*70cm
voltage: 220V
power: 1.2kw
weight: 15kg
price: **\$380**



electric bun toaster

model: GF-212
size: 41*70*33cm
voltage: 220V
power: 2kw
weight: 25.6kg
price: **\$300**



counter top chips warmer

model: VF-8
size: 80*71*65cm
voltage: 220V
power: 0.6kw
weight: 27.5kg
price: **\$250**



electric convection oven

model: EB-1A
size: 59.5*53*57cm
voltage: 220V
power: 2kw
weight: 39kg
price: **\$380**



electric pizza oven

model: LD-1S
size: 112.5*58*43.5cm
voltage: 220V
power: 6.7kw
work area: 560*385mm
weight: 49kg
price: **\$1150**



electric pizza oven

model: LD-2S
size: 146*58*43.5cm
voltage: 380V
power: 6.7kw
work area: 560*385mm
weight: 49kg
price: **\$1580**



electric pizza oven

model: EB-2M
size: 56*53*43cm
voltage: 220V
power: 3kw
weight: 36kg
price: **\$330**



build-in steam oven

model: CQ972
size: 59.5*52*45.5cm
voltage: 220V
power: 2.8kw
capacity: 45L
weight: 31.5kg
price: **\$800**



electric smokeless barbecue grill

model: EB-580
size: 58*38.5*24cm
voltage: 220V
power: 2.6kw
weight: 6.18kg
price: **\$100**



electric smokeless barbecue grill

model: EB-220
size: 110*48*24cm
voltage: 220V
power: 7.8kw
weight: 14.4kg
price: **\$160**



chocolate stove

model: EH-24
size: 48*36.5*17.5cm
voltage: 220V
power: 1.5kw
weight: 6.5kg
price: **\$170**



rolling hog dog machine
 model: EH-207
 size: 58.5*33*43cm
 voltage: 220V
 power: 1.4kw
 weight: 15kg
 price: **\$160**



rolling hot dog machine
 model: EH-209
 size: 58.5*40.5*43cm
 voltage: 220V
 power: 1.8kw
 weight: 20kg
 price: **\$200**



heart shape waffle baker
 model: EG-5A
 size: 25.5*50*19cm
 voltage: 220V
 power: 1.09kw
 weight: 18kg
 price: **\$140**



heart shape waffle baker
 model: EG-5A-2
 size: 51.5*50*19cm
 voltage: 220V
 power: 2.18kw
 weight: 36kg
 price: **\$250**



hot dog waffle machine
 model: EG-7A
 size: 25.5*50*19cm
 voltage: 220V
 power: 1.09kw
 weight: 18kg
 price: **\$120**



hot dog waffle machine
 model: EG-7A-2
 size: 51.5*50*19cm
 voltage: 220V
 power: 2.18kw
 weight: 36kg
 price: **\$200**



donut machine
 model: EG-6A
 size: 25.5*50*19cm
 voltage: 220V
 power: 1.09kw
 weight: 18kg
 price: **\$120**



donut machine
 model: EG-6A-2
 size: 51.5*50*19cm
 voltage: 220V
 power: 2.18kw
 weight: 36kg
 price: **\$200**



waffle machine
 model: UWB-1B
 size: 25.5*50*19cm
 voltage: 220V
 power: 1.09kw
 weight: 18kg
 price: **\$120**



waffle machine
 model: UWB-1B-2
 size: 51.5*50*19cm
 voltage: 220V
 power: 2.18kw
 weight: 36kg
 price: **\$200**



rotary waffle machine
 model: UWB-1A
 size: 22*50*27cm
 voltage: 220V
 power: 1.4kw
 weight: 15kg
 price: **\$150**



egg cake baker
 model: EG-30
 size: 22*36*27cm
 voltage: 220V
 power: 1.4kw
 weight: 5.5kg
 price: **\$120**



fish crisps baker
 model: EG-6Q
 size: 38.5*33*30cm
 voltage: 220V
 power: 1.5kw
 weight: 8kg
 price: **\$140**



electric cotton candy
 model: MH-500
 size: 50*50*53cm
 voltage: 220V
 power: 0.9kw
 weight: 12.8kg
 price: **\$200**



electric popcorn machine
 model: EB-801
 size: 50*36*68cm
 voltage: 220V
 power: 1.4kw
 capacity: 8 oz
 weight: 18kg
 price: **\$130**



water boiler
 model: WB-40
 size: 20*38.5*50cm
 voltage: 220V
 power: 3kw
 output: 40L/H
 weight: 9kg
 price: **\$100**



electric toaster
 model: 6ATS
 size: 42*27*22.5cm
 voltage: 220V
 power: 2.5kw
 weight: 5.5kg
 price: **\$130**



electric conveyor toaster
 model: EB-300
 size: 36.8*41.8*38.7cm
 voltage: 220V
 power: 2kw
 weight: 16kg
 price: **\$440**



automatic donut machine
 model: NP-2
 size: 96.5*36*64cm
 voltage: 110/220V
 power: 3kw
 weight: 40kg
 price: **\$1080**



automatic donut machine
 model: SK-T1
 size: 102*55*68cm
 voltage: 220V
 power: 6kw
 weight: 43kg
 price: **\$1770**



semi-automatic coffee machine

model: ECP35.31
size: 18.5*24*30.5cm
voltage: 220V
power: 1.1kw
capacity: 1.1L
weight: 4.5kg
price: **\$160**



espresso machine

model: CM- 3120C
size: 816*504*565mm
voltage: 220V
power: 4.2kw
boiler capacity 12L
weight: 43kg
price: **\$2450**



food grinder

model: P132
size: 42*24*36cm
voltage: 220V
power: 0.9kw
capacity: 1.8L
weight: 5.1kg
price: **\$120**



automatic sealing machine

model: BST-FKJ01
size: 255*355*565mm
voltage: 220V
power: 280w
weight: 26.5kg
price: **\$300**



sugur dispenser

model: BST-GTJ
size: 2535.5*41.5cm
voltage: 220V
power: 280w
capacity: 10L
weight: 18kg
price: **\$140**



auto fruit slicing machine

model: JS-605
size: 27*22*43cm
voltage: 220V
power: 0.6kw
capacity: 2L
weight: 12kg
price: **\$230**



auto tornado potato slicer

model: YHD-50
size: 65*15*18cm
voltage: 110~240V
power: 80w
weight: 7kg
skewers length: ≤50cm
price: **\$250**



auto tornado potato slicer

model: YHD-60
size: 78*15*18cm
voltage: 110~240V
power: 80w
weight: 8kg
skewers length: ≤60cm
price: **\$300**

working bench fridge/
freezer
temperature: -20~15°C
voltage: 110/220V
power: 0.21kw
weight: 50kg
120*60*80cm, \$450
150*60*80cm, \$500
180*60*80cm, \$550



2 compressors half
fridge half freezer
temperature: -20~15°C
voltage: 110/220V
power: 0.42kw
weight: 80kg
180*60*80cm: \$650
200*60*80cm: \$700



salad/ pizza bench fridge
temperature: -20~15°C
voltage: 110/220V
power: 0.21kw
weight: 50kg
120*60*80cm, \$650
150*60*80cm, \$700
180*60*80cm, \$750



salad/ pizza bench fridge
temperature: -20~15°C
voltage: 220V
power: 0.21kw
weight: 70kg
120*60*80cm, \$750
150*60*80cm, \$800
180*60*80cm, \$850



salad/ pizza marble surface
fridge
temperature: -20~15°C
voltage: 220V
power: 0.21kw
weight: 80kg
120*60*80cm, \$1050
150*60*80cm, \$1150
180*60*80cm, \$1250



counter top soft ice cream
machine
model: MQ- L20ABN
size: 54.4*71*85cm
voltage: 220V
power: 1.9kw
Flavour: 3
weight: 88kg
price: \$810



soft ice cream machine
model: MQ- L20BN
size: 50.4*70.5*117.7cm
voltage: 220V
power: 1.9kw
Flavour: 3
weight: 98kg
price: \$850



ice maker
model: ICM-55
size: 44.8*40*79.8cm
voltage: 220V
power: 0.2kw
capacity: 55kg/24h
ice storage: 18kg
price: \$280



crescent ice maker
model: BTM-260
size: 90*70*80cm
voltage: 110/220V
power: 0.8kw
capacity: 120kg/24h
ice storage: 50kg
weight: 78kg
price: \$1400



70L drinks fridge
model: YDF-70
size: 44*50*70cm
voltage: 220V
power: 0.85kw/h/ 24h
temperature: 2~8°C
weight: 24kg
price: \$190



Standing drinks fridge
model: YDF-150
size: 50*53.5*112cm
voltage: 220V
power: 0.1kw
temp: 0~10°C
weight: 35kg
price: \$330



standing drinks fridge
model: YDF-260
size: 55*53.5*157.5cm
voltage: 220V
power: 0.12kw
temp: 0~10°C
weight: 45kg
price: \$420



standing drinks fridge
model: YDF-480
size: 972*565*1645mm
voltage: 220V
power: 0.2kw
temp: 0~10°C
weight: 90kg
price: \$750



Standing drinks fridge
model: YDF-780
size: 110*60*201cm
voltage: 220V
power: 0.27kw
temp: 2~8°C
weight: 120kg
price: \$670



3 doors standing drinks fridge
model: YDF-1200
size: 168*60*201cm
voltage: 220V
power: 0.35kw
temp: 2~8°C
weight: 170kg
price: \$1080



2 doors kitchen freezer
model: GD-2
size: 60*73*195cm
voltage: 220V
power: 0.21kw
temp: 0~-15°C
weight: 80kg
price: \$680



4 doors kitchen
refrigerator
model: GD-4
size: 120*73*195cm
voltage: 220V
power: 0.45kw
temp: 0~10°C, -5~-18°C
weight: 160kg
price: \$880



mini ice cream rolls
machine
model: YIR-1
size: 34*28*30cm
voltage: 220V
power: 0.33kw
weight: 15kg
price: \$240

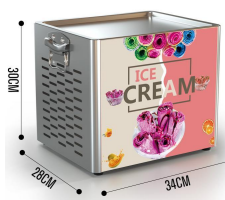

ice cream rolls machine
model: YIR-2
size: 72*54*118cm
pan size: 54*32cm
voltage: 220V
power: 0.8kw
weight: 45kg
price: \$620



2 tanks juice machine
model: YJM-1
size: 40*31*71cm
voltage: 220V
power: 0.31kw
capacity: 2*18L
weight: 22kg
price: \$380





3 tanks juice machine

model: YJM-2
size: 73*40*64cm
voltage: 220V
power: 0.31kw
capacity: 3*18L
weight: 39kg
price: **\$500**



slush machine

model: YS-1
size: 24*53*80cm
voltage: 220V
power: 0.55kw
capacity: 12L
weight: 25kg
price: **\$720**



2-tank slush machine

model: YS-2
size: 43*53*80cm
voltage: 220V
power: 0.89kw
capacity: 2*12L
weight: 45kg
price: **\$970**



3 tanks slush machine

model: YS-3
size: 62*53*80cm
voltage: 220V
power: 1.1kw
capacity: 3*12L
weight: 65kg
price: **\$1200**



counter top fridge cake showcase

temperature: 2-8°C
voltage: 220V
power: 0.25kw
weight: 80kg
90*50*75cm, **350\$**
120*50*75cm, **380\$**



counter top fridge cake showcase

temperature: 2-8°C
voltage: 220V
power: 0.25kw
weight: 80kg
90*50*75cm, **350\$**
120*50*75cm, **380\$**



counter top sushi display fridge

temperature: 2-8°C
voltage: 220V
power: 0.3kw
weight: 60kg
120*41*45cm, **\$380**
150*41*45cm, **\$410**
180*41*45cm, **\$450**



counter top sushi display fridge

temperature: 2-8°C
voltage: 220V
power: 0.3kw
weight: 60kg
120*41*45cm, **\$380**
150*41*45cm, **\$410**
180*41*45cm, **\$450**



Ice cream showcase

model: YIF-1
size: 99*69*123cm
voltage: 220V
power: 0.17kw
capacity: 10 pots or 6 buckets
weight: 80kg
price: **\$520**



Ice cream showcase

model: YIF-2
size: 117*69*123cm
voltage: 220V
power: 0.21kw
capacity: 12 pots or 8 buckets
weight: 95kg
price: **\$550**



Ice cream showcase

model: YIF-3
size: 133*69*123cm
voltage: 220V
power: 0.23kw
capacity: 14 pots or 8 buckets
weight: 110kg
price: **\$590**



beer dispenser

model: YBD-01
size: 60.4*79.1*100cm
voltage: 220V
power: 0.33kw
capacity: 4*20L
temp: 0~8°C
weight: 60kg
price: **\$1850**